

# HSG

Headquarters Add.: No. 8, Zhujiang Avenue, Bijiang Industrial Zone,  
Beijiao Town, Shunde District, Foshan, China  
Website: [www.hsglaser.com](http://www.hsglaser.com)  
Email: [info@hsglaser.com](mailto:info@hsglaser.com)  
Tel: +86 757-66833906



PRODUCT VIDEO

خط ویژه: ۰۲۱-۴۱۴۰۳

[WWW.LASERPKM.COM](http://WWW.LASERPKM.COM)



شرکت مهندسی پارس کیا مهنام  
نماینده انحصاری HSG Laser در ایران

# HSG



▪ TUBE METAL LASER CUTTING MACHINE ▪

خط ویژه: ۰۲۱-۴۱۴۰۳

[WWW.LASERPKM.COM](http://WWW.LASERPKM.COM)



شرکت مهندسی پارس کیا مهنام  
نماینده انحصاری HSG Laser در ایران





## A National Hi-tech Enterprise

HSG Laser, founded in 2006, as a national hi-tech enterprise with an eye to R&D, production and sales of laser equipment, is now mainly dedicated to serve global customers with intelligent metal forming solutions. HSG Laser has applied for nearly 500 patents.



## Serve 100+ Countries and Regions

HSG Laser has 2 wholly-owned subsidiaries in Germany and Japan, 4 standardized manufacturing bases in China and 30+ service outlets overseas. 1500+ workers, incl. 180+ R&D personnel sold 3000+ machines in 2020 by right of 80000m2 factories and 5000+ annual productivity.



## Professional R&D Team

Our R&D team values high-power machines and key spare parts. Until now, they have developed industry-leading 3D five-axis cutting, P20 ultra-high-power intelligent laser cutting head, intelligent digital four chucks, Alpha T bus system and HSG-XMT multi-touch operating system.



## Laser Cutting Machines of a Great Variety

HSG Laser can serve global users with 20+ kinds of machines that are suitable for most materials needing to be cut, including sheet metal laser cutting machine, sheet & tube laser cutting machine, tube metal laser cutting machine, bending machine and welding machine.

خط ویژه: ۰۲۱-۴۱۴۰۳

[WWW.LASERPKM.COM](http://WWW.LASERPKM.COM)



شرکت مهندسی پارس کیا مهنام  
نماینده انحصاری HSG Laser در ایران





OUR  
HEADQUARTERS

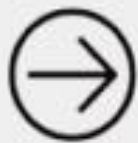

SUZHOU  
SUBSIDIARY



GERMAN  
SUBSIDIARY



JINAN  
SUBSIDIARY



JAPANESE  
SUBSIDIARY



خط ویژه: ۰۲۱-۴۱۴۰۳

[WWW.LASERPKM.COM](http://WWW.LASERPKM.COM)



شرکت مهندسی پارس کیا مهنام  
نماینده انحصاری HSG Laser در ایران

# R5 Series

Full-automatic Tube Laser Cutting Machine 1500-4000W



## Technical Parameters

Technical Parameter	R5
Power	1500-4000W
Max. No-load Speed	100m/min
Max. Chuck Speed	100r/min
X/Y-axis Positioning Accuracy	$\pm 0.03\text{mm/m}$
X/Y-axis Repositioning Accuracy	$\pm 0.03\text{mm}$
Max. Acceleration	1.0G
Processing Materials	Round tube dia. $\Phi 20-254\text{mm}$ , square tube dim. $20^*20-200^*200\text{mm}$ , rectangular tube: side length $\leq 200\text{mm}$
Standard Cutting Length	6500mm
Max. Weight of Single Tube	200kg
Overall Dimensions (L*W*H), incl. Loading Rack	12400*5300*2500mm

## Cutting Samples



خط ویژه: ۰۲۱-۴۱۴۰۳

[WWW.LASERPKM.COM](http://WWW.LASERPKM.COM)



شرکت مهندسی پارس کیا مهنام  
نماینده انحصاری HSG Laser در ایران



## THIRD GENERATION HSG-X9000 INTELLIGENT CONTROL SYSTEM

Click a button to invoke the built-in tube graph library, no need for manual programming;  
Closed-loop CNC control system, self-adaptive control of clamping force, easy to operate and get started;  
Show tube graphs, air pressure, power, speed data and core parts on its screen in real time and offer machine bed debugging and maintenance plan;  
Imported SigmaTube nesting software brings high utilization and saves production costs.



## PROFESSIONAL DOUBLE PNEUMATIC CHUCKS

Max. rotating speed and acceleration are 100r/min and 1.0G. One-button clamping, no need for changing claws while tube diameter varies from 20 to 254mm, minimizing non-productive duration and saving labor costs & efficiency by 50% and 20%+ respectively. Round tube dia. 20-254mm, square tube 20\*20-200\*200mm. In addition, R5 can also cut rectangular tube as well as angle, channel and H-shaped steel.

## AUTOFOCUS LASER CUTTING HEAD

Based on Germany technology, our sharp-pointed autofocus laser cutting head is fast in punching and can meet the cutting demands of tubes in most shapes and materials.



خط ویژه: ۰۲۱-۴۱۴۰۳

[WWW.LASERPKM.COM](http://WWW.LASERPKM.COM)



شرکت مهندسی پارس کیا مهنام  
نماینده انحصاری HSG Laser در ایران



## INTELLIGENTIZED PRODUCTION LINE

Automatic loading & unloading system is equipped to speed up the loading (19s required at the soonest) and sort out finished products & wastes, reducing the dependence on labor force and the labor intensity of workers. Moreover, our V- and Y-shaped supporting brackets can prevent tubes moving or collision and make tube center point positioning more accurate.



## SMALL SIZE, SAVE FREIGHT

20% smaller in size (L\*W 9940mm\*2600mm) than same-grade models, be operated easily in a crowded workshop, increasing the utilization of factory, and easily put in 40HQ+20GP or 40HQ+40HQ+20GP container.

### Field Of Application



Furniture



Kitchenware

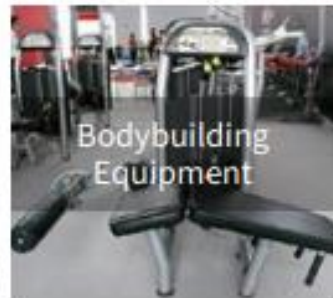

Bodybuilding Equipment

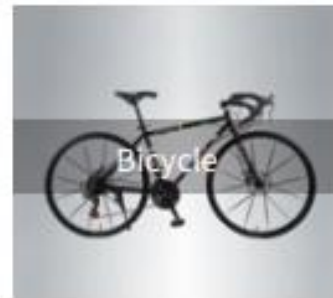

Bicycle



Car Seats



Goods Shelves



Building Materials



Doors And Windows

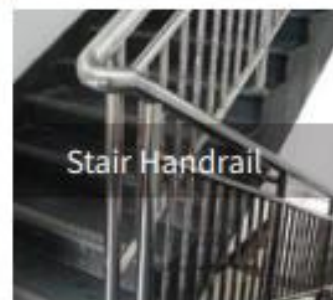

Stair Handrail



Fencing

خط ویژه: ۰۲۱-۴۱۴۰۳

[WWW.LASERPKM.COM](http://WWW.LASERPKM.COM)



شرکت مهندسی پارس کیا مهنام  
نماینده انحصاری HSG Laser در ایران



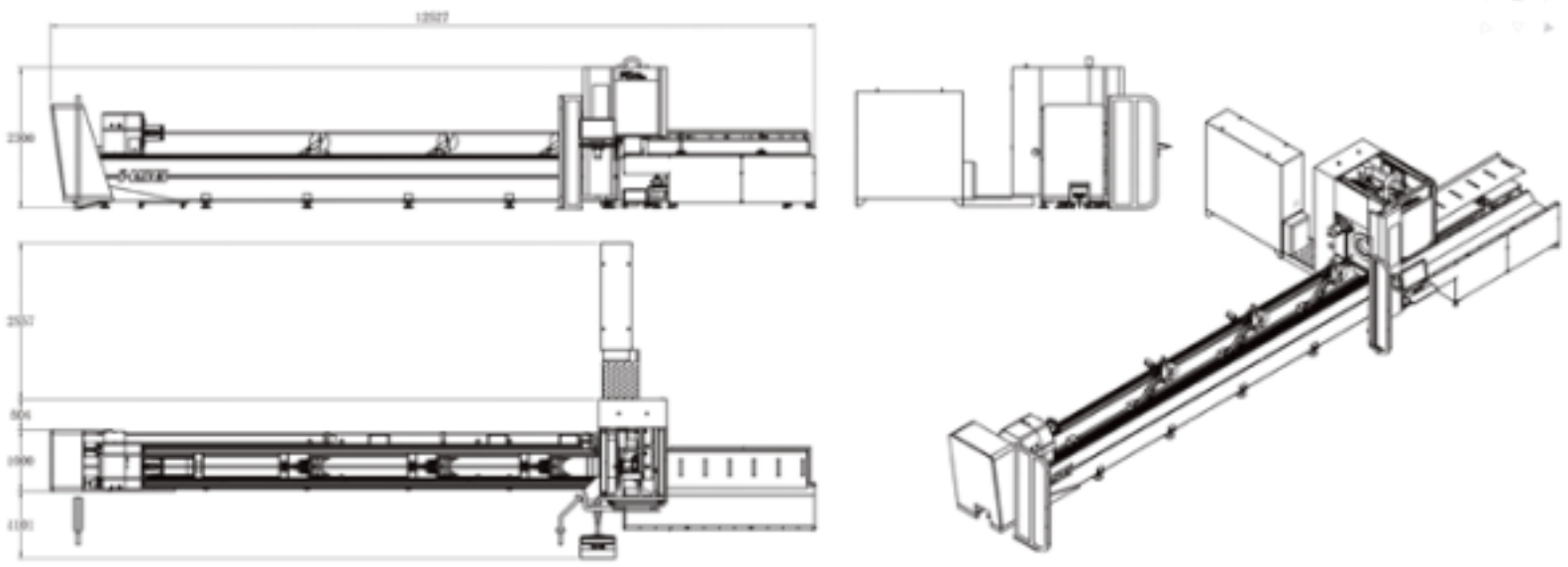

### Core accessories

### IPG: Laser device

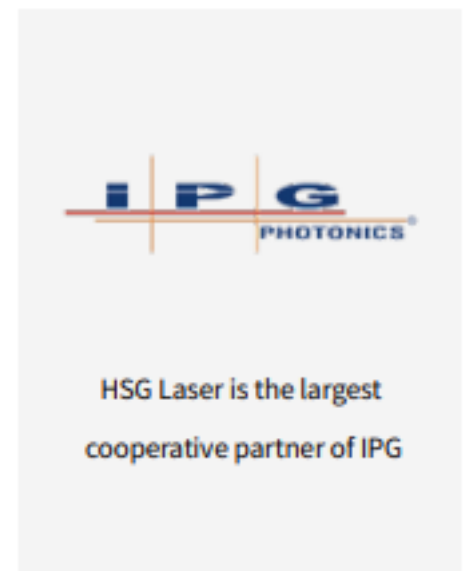

### Cutting Effects

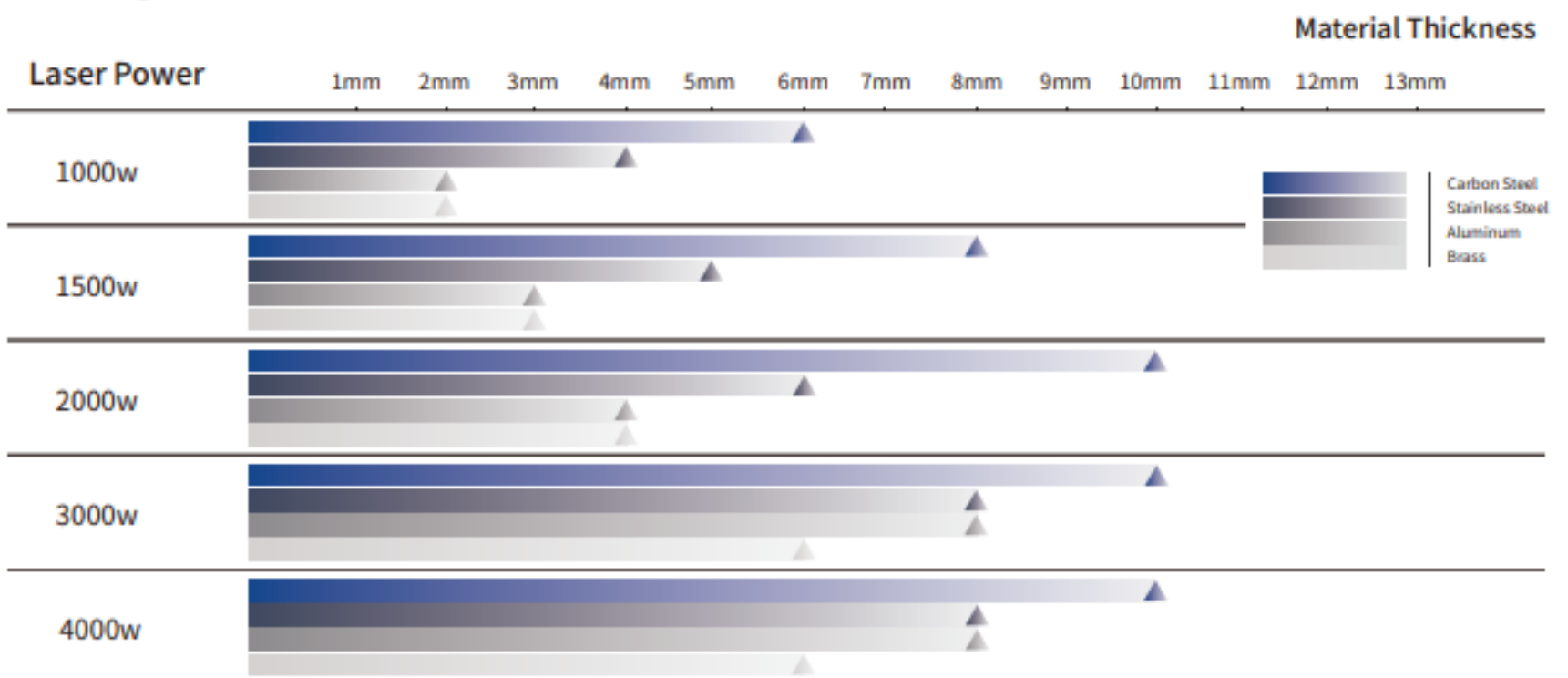

خط ویژه: ۰۲۱-۴۱۴۰۳

WWW.LASERPKM.COM



شرکت مهندسی پارس کیا مهنام  
نماینده انحصاری HSG Laser در ایران